

Dynamic[®]

Best Bounding with Brass

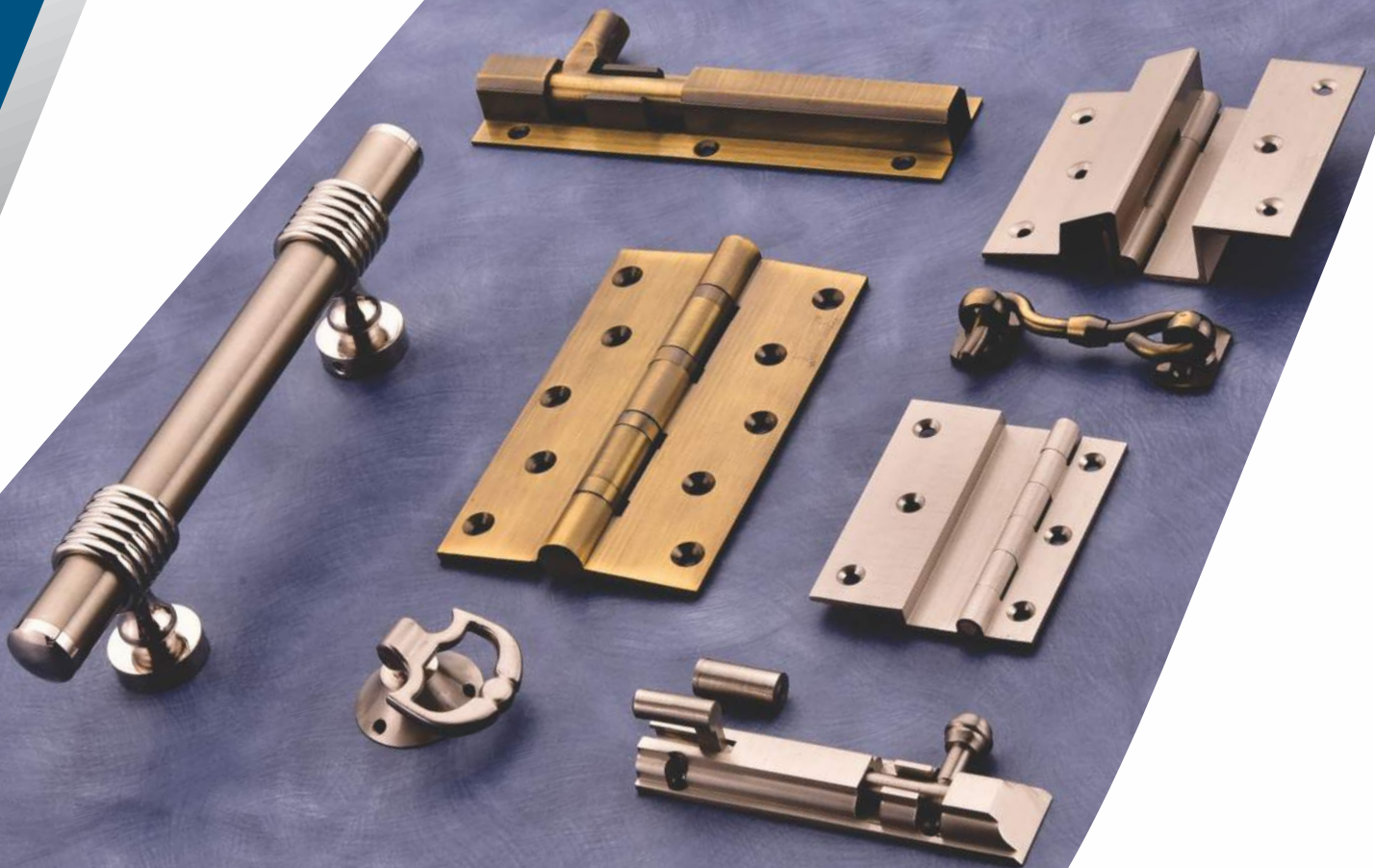

***“Quality means doing it right
when no one is looking.”***

PRODUCT CATALOGUE 2022



Dynamic®

Best Bounding with Brass

Company Profile

It gives us immense pleasure and pride presenting this Catalogue and to introduce ourselves as leading manufacturer of Builders Hardware fittings since 1988 in manufacturing exclusive quality products. With our huge experience introducing our new Exclusive brand DYNAMIC. We have a Exclusive range of Hinges, Brass Tower Bolts & Fittings.

We have all the latest technologies for manufacturing our products from scrap and finishing it to final product. Our production line consist of casting, machining, polishing, plating, and packing. Each department has its own quality control personnel, who is always on his heels, testing each and every batch for quality consistency. We are having a very experienced skilled technical staff, who lead our workforce to achieve perfection at every stage.

We also take care of pollution control. In our manufacturing process there are no such by-products or residue which could harm the ecology of the environment. Safety and well-being of our workmen is also a prime subject of our set-up and is taken care of very properly.

Innovation and R&D are non-ending activity at our end. Our products match to the inter-national standards of best workmanship, finish, and packing. We are confident enough that we can cater world over to the almost all the requirements in Brass & Steel Hardware and Brass Parts

Term & Conditions :

1. Applicable taxes will be charged extra.
2. Discount on product rate (except fix rate products) will charge as per scrap rate mentioned below
500=510 511=520 521=530 531=540 541=550
3. Rates will charge of selected fix rate products in this price list as per scrap rate up/down.
4. Payment promptly against despatch delivery.
5. Goods once sold will not be taken back in any circumstances.
6. Disputes subject to Jamnagar Jurisdictions.



HINGES

AN ISO 9001-2008 CERTIFIED COMPANY



Best Bounding with Brass

(M.R.P WITH SCREW)

GRAPHITE PVD FINISH

BUTT HINGES - 3/32 (M.R.P. PER PIECE)

S.S.F. / ANTIQ

CODE NO.	SIZE MM/INCH		S.S.F. / ANTIQ				
			M.R.P. Medium	M.R.P. Heavy	M.R.P. Heavy Smooth Movement	M.R.P. Heavy Smooth Movement	M.R.P. Heavy Smooth Movement
A-1	3X3/8X5/8	75X9X10	71.00	74.00	78.00	98.00	150.00
A-2	3X1/2X3/4	75X12X18	76.00	84.00	90.00	112.00	166.00
A-3	3X3/4X3/4	75X18X18	88.00	96.00	101.00	124.00	184.00
A-4	3X7/8X7/8	75X21X21	102.00	110.00	116.00	132.00	206.00
A-5	3X1/2X1	75X12X25	92.00	98.00	104.00	128.00	188.00
A-6	3X3/4X1	75X18X25	100.00	109.00	116.00	140.00	206.00
A-7	3X1X1	75X25X25	118.00	121.00	130.00	156.00	224.00
A-8	3X3/8X1.1/8	75X9X28	---	93.00	98.00	120.00	178.00
A-9	3X1/2X1.1/2	75X12X36	---	144.00	150.00	178.00	252.00
A-10	4X3/8X5/8	100X9X10	96.00	100.00	106.00	134.00	206.00
A-11	4X1/2X3/4	100X12X18	104.00	114.00	121.00	150.00	230.00
A-12	4X3/4X3/4	100X18X18	118.00	129.00	138.00	170.00	256.00
A-13	4X7/8X7/8	100X21X21	138.00	150.00	160.00	194.00	286.00
A-14	4X1/2X1	100X12X25	126.00	134.00	143.00	174.00	260.00
A-15	4X3/4X1	100X18X25	132.00	146.00	154.00	188.00	278.00
A-16	4X1X1	100X25X25	158.00	160.00	170.00	206.00	302.00
A-17	4X1/2X1.1/2	100X12X36	---	192.00	198.00	236.00	340.00
A-18	RLY 3X3/4X3/4	75X18X18	---				



BUTT HINGES



RAILWAY HINGES FIX PIN

RAILWAY HINGES (REGULAR QUALITY) FIXPIN

S.S.F. / ANTIQ

CODE NO.	SIZE MM/INCH		S.S.F. / ANTIQ	
			M.R.P. Regular	M.R.P. Smooth Movement
C-1	3X7/8X7/8 (Medium)	75X21X2	113.00	120.00
C-2	3X7/8X7/8 (Havey)	75X21X2.5	132.00	138.00
C-3	3X1X1/8	75X25X2.5	136.00	140.00
C-4	4X1X1/8	100X25X2.5	172.00	178.00
C-5	5X1X1/8	125X25X2.5	220.00	228.00
C-6	4X1.1/8X1/8	100X28X2.5	204.00	212.00
C-7	5X1.1/8X1/8	125X28X2.5	252.00	262.00
C-8	6X1.1/8X1/8	150X28X2.5	310.00	318.00
C-9	4X1.1/8X5/32 (Medium)	100X28X3	240.00	250.00
C-10	4X1.1/8X5/32 (Havey)	100X28X3.5	292.00	304.00
C-11	5X1.1/8X5/32 (Medium)	125X28X3	302.00	314.00
C-12	5X1.1/8X5/32 (Havey)	125X28X3.5	366.00	380.00
C-13	6X1.1/8X5/32 (Havey)	150X28X3.5	436.00	450.00
C-14	5X1.1/4X5/32	125X31X3	400.00	412.00
C-15	6X1.1/4X5/32	150X31X3	484.00	500.00
C-16	5X1.1/4X3/16	125X31X4	518.00	536.00
C-17	6X1.1/4X3/16	150X31X4	622.00	644.00
C-18	5X1.1/2X3/16	125X37X4	582.00	610.00
C-19	6X1.1/2X3/16	150X37X4	696.00	726.00



HINGES

AN ISO 9001-2008 CERTIFIED COMPANY



Best Bounding with Brass

RAILWAY HINGES SMOOTH MOVEMENT



S.S.F.

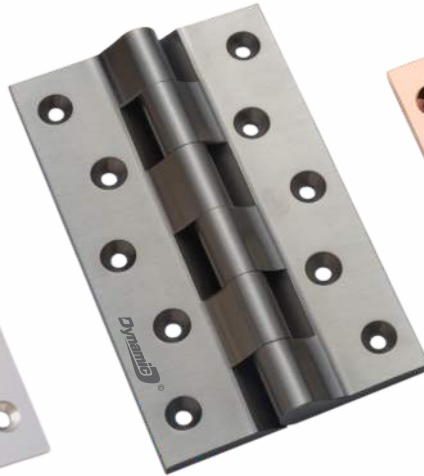

GRAPHITE
FINISH

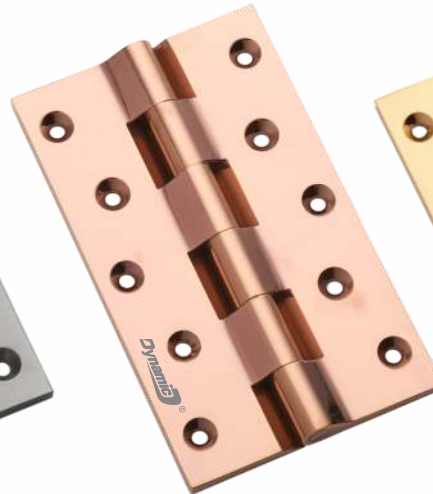

PVD ROSE GOLD
FINISH

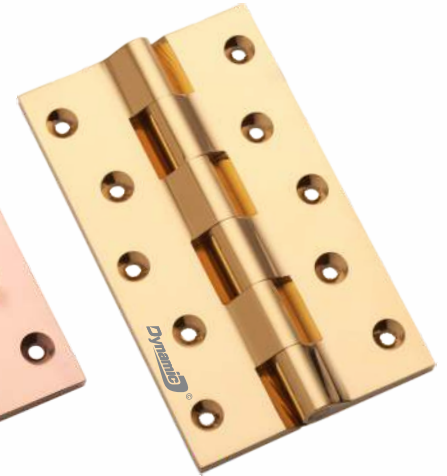

PVD GOLD
FINISH

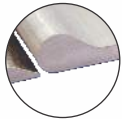

Pin Locking System
Steel Pin locked between Brass Rivets
at top and bottom for extra safety
for doors & windows

WITH PIN LOCKING SYSTEM RAILWAY HINGES (HEAVY) (M.R.P. PER PIECE)

(M.R.P. WITH SCREW)

CODE NO.	SIZE MM/INCH		S.S.F. / ANTIQ GRAPHITE PVD FINISH		
			M.R.P. Heavy Smooth Movement	M.R.P. Heavy Smooth Movement	M.R.P. Heavy Smooth Movement
B-1	3x7/8x7/8	75x21x2	154.00	184.00	264.00
B-2	3x1x1/8	75x25x3	198.00	234.00	336.00
B-3	4x1x1/8	100x25x3	260.00	312.00	452.00
B-4	5x1x1/8	125x25x3	326.00	390.00	566.00
B-5	4x1.1/8x1/8	100x28x3	274.00	328.00	472.00
B-6	5x1.1/8x1/8	125x28x3	342.00	408.00	590.00
B-7	6x1.1/8x1/8	150x28x3	412.00	490.00	700.00
B-8	4x1.1/8x5/32	100x28x3.5	348.00	406.00	588.00
B-9	5x1.1/8x5/32	125x28x3.5	424.00	512.00	730.00
B-10	6x1.1/8x5/32	150x28x3.5	514.00	604.00	858.00
B-11	5x1.1/4x5/32	125x31x3.5	470.00	554.00	790.00
B-12	6x1.1/4x5/32	150x31x3.5	566.00	664.00	938.00
B-13	5x1.1/4x3/16	125x31x4.5	586.00	686.00	970.00
B-14	6x1.1/4x3/16	150x31x4.5	712.00	828.00	1162.00
B-15	5x1.1/2x3/16	125x37x4.5	764.00	900.00	1240.00
B-16	6x1.1/2x3/16	150x37x4.5	918.00	1074.00	1474.00
B-17	8x1.1/2x3/16	200x37x4.5	1242.00	1454.00	1998.00
B-18	10x2x3/16	250x50x4.5	2392.00	2710.00	3544.00
B-19	12x2x3/16	300x50x4.5	2870.00	3240.00	4230.00
B-20	5x1.1/4x6MM Ex. Havey	125x31x6	958.00	1112.00	1506.00
B-21	6x1.1/4x6MM Ex. Havey	150x31x6	1150.00	1328.00	1794.00
B-22	5x1.1/2x6MM Ex. Havey	125x37x6	1120.00	1294.00	1748.00
B-23	6x1.1/2x6MM Ex. Havey	150x37x6	1330.00	1530.00	2062.00
B-24	8x1.1/2x6MM Ex. Havey	200x37x6	1880.00	2154.00	2884.00



HINGES

AN ISO 9001-2008 CERTIFIED COMPANY



Best Bounding with Brass
(M.R.P. PER PIECE)



ANTIQUÉ FINISH

RAILWAY S/S WASHER HINGES
S.S. Washer with Pin Locking System

WITH FIXPIN
WASHER RAILWAY HINGES (M.R.P. PER PIECE)

(M.R.P. WITH SCREW)

— S.S.F. / ANTIQ — GRAPHITE PVD FINISH

CODE NO.	SIZE MM/INCH		M.R.P. Fix Pin	S.S.F. / ANTIQ		GRAPHITE PVD FINISH	
				M.R.P. Heavy Smooth Movement	M.R.P. Heavy Smooth Movement	M.R.P. Heavy Smooth Movement	M.R.P. Heavy Smooth Movement
D-1	4x1x1/8	100x25x3	288.00	312.00	364.00	508.00	
D-2	5x1x1/8	125x25x3	360.00	392.00	458.00	636.00	
D-3	4x1.1/8x1/8	100x28x3	310.00	338.00	394.00	546.00	
D-4	5x1.1/8x1/8	125x28x3	390.00	422.00	492.00	682.00	
D-5	6x1.1/8x1/8	150x28x3	474.00	518.00	596.00	816.00	
D-6	4x1.1/8x5/32	100x28x3.5	382.00	416.00	480.00	658.00	
D-7	5x1.1/8x5/32	125x28x3.5	466.00	506.00	586.00	806.00	
D-8	6x1.1/8x5/32	150x28x3.5	568.00	620.00	712.00	968.00	
D-9	5x1.1/4x5/32	125x31x4	536.00	584.00	672.00	920.00	
D-10	6x1.1/4x5/32	150x31x4	656.00	714.00	812.00	1106.00	
D-11	5x1.1/4x3/16	125x31x4.5	590.00	644.00	740.00	1004.00	
D-12	6x1.1/4x3/16	150x31x4.5	730.00	792.00	904.00	1222.00	
D-13	5x1.1/2x3/16	125x37x4.5	756.00	824.00	956.00	1284.00	
D-14	6x1.1/2x3/16	150x37x4.5	930.00	1010.00	1162.00	1550.00	
D-15	8x1.1/2x3/16	200x37x4.5	---	1416.00	1624.00	2156.00	

BEARING HINGES
With Mirror cap

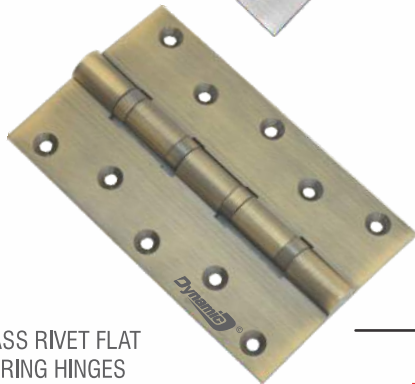

BRASS RIVET FLAT BEARING HINGES
ANTIQUÉ FINISH



Pin Locking System
Steel Pin locked between Brass Rivets at top and bottom for extra safety for doors & windows

BEARING HINGES

— S.S.F. / ANTIQ —

CODE NO.	SIZE MM/INCH	S.S.F. / ANTIQ		
		M.R.P. Medium	M.R.P. Heavy	Brass Rivet Flat
E-1	3X2X2.5MM	---	196.00	---
E-2	3X2.5X3MM	---	244.00	---
E-3	4X3X3MM	328.00	342.00	368.00
E-4	5X3X3MM	416.00	428.00	446.00
E-5	6X3X3MM	498.00	514.00	552.00
E-6	4X3X4MM	408.00	432.00	472.00
E-7	5X3X4MM	510.00	526.00	552.00
E-8	6X3X4MM	598.00	628.00	678.00
E-9	5X3X5MM	690.00	780.00	724.00
E-10	6X3X5MM	822.00	932.00	866.00
E-11	5X3.5X5MM	778.00	860.00	876.00
E-12	6X3.5X5MM	932.00	1028.00	1080.00
E-13	8X3.5X5MM	---	1500.00	1618.00
E-14	5X4X5MM	---	1012.00	1086.00
E-15	6X4X5MM	---	1214.00	1302.00
E-16	8X4X5MM	---	1734.00	1886.00



HINGES

AN ISO 9001-2008 CERTIFIED COMPANY



Best Bounding with Brass
(M.R.P. PER PIECE)



L. HINGES



Our **L-Hinges 90°** Lock is convenient way to avoid Rod latch, Door chain.



L - HINGES (90° LOCK)

L HINGES REGULAR AND 90 DEGREE LOCK

S.S.FINISH

CODE NO.	SIZE MM/INCH	S.S.FINISH		
		M.R.P. Regular	M.R.P. Medium	M.R.P. Heavy
H-1	3x3/8x1.1/4x6MM	99.00	114.00	124.00
H-2	3x1/2x1.1/2x6MM	110.00	130.00	150.00
H-3	3x3/4x1.3/4x6MM		156.00	186.00
H-4	3x1x2x6MM			206.00
H-5	3x3/8x1.1/4x12MM	112.00	130.00	140.00
H-6	3x1/2x1.1/2x12MM	130.00	146.00	154.00
H-7	3x3/4x1.3/4x12MM		166.00	192.00
H-8	3x1x2x12MM			228.00
H-9	3x3/8x1.1/4x19MM	124.00	138.00	148.00
H-10	3x1/2x1.1/2x19MM	139.00	156.00	182.00
H-11	3x3/4x1.3/4x19MM		182.00	204.00
H-12	3x1x2x19MM			250.00
H-13	3x1/2x1.1/2x25MM		178.00	200.00
H-14	3x3/4x1.3/4x25MM			224.00
H-15	3x1x2x25MM			260.00
H-16	4x3/8x1.1/4x6MM	130.00	160.00	180.00
H-17	4x1/2x1.1/2x6MM		178.00	204.00
H-18	4x3/4x1.3/4x6MM		224.00	244.00
H-19	4x1x2x6MM			300.00
H-20	4x3/8x1.1/4x12MM		176.00	196.00
H-21	4x1/2x1.1/2x12MM		202.00	222.00
H-22	4x3/4x1.3/4x12MM		230.00	256.00
H-23	4x1x2x12MM			320.00
H-24	4x3/8x1.1/4x19MM		198.00	214.00
H-25	4x1/2x1.1/2x19MM		226.00	244.00
H-26	4x3/4x1.3/4x19MM		252.00	278.00
H-27	4x1x2x19MM			330.00
H-28	4x1/2x1.1/2x25MM			268.00
H-29	4x3/4x1.3/4x25MM			298.00
H-30	4x1x2x25MM			358.00



HINGES

AN ISO 9001-2008 CERTIFIED COMPANY



Best Bounding with Brass
(M.R.P. PER PIECE)



L- Hinge (90° Lock)



L - HINGES (90° LOCK)



L. HINGES

**REGULAR AND 90 DEGREE LOCK
L HINGES (SMOOTH MOVEMENT)**

S.S.FINISH

CODE NO.	SIZE MM/INCH	S.S.FINISH	
		Medium Smooth Movement	Heavy Smooth Movement
M-1	3X3/8X1.1/4X6MM	120.00	130.00
M-2	3X1/2X1.1/2X6MM	138.00	158.00
M-3	3X3/4X1.3/4X6MM	166.00	198.00
M-4	3X1X2X6MM	----	220.00
M-5	3X3/8X1.1/4X12MM	138.00	144.00
M-6	3X1/2X1.1/2X12MM	154.00	162.00
M-7	3X3/4X1.3/4X12MM	178.00	208.00
M-8	3X1X2X12MM		250.00
M-9	3X3/8X1.1/4X19MM	146.00	158.00
M-10	3X1/2X1.1/2X19MM	158.00	190.00
M-11	3X3/4X1.3/4X19MM	194.00	218.00
M-12	3X1X2X19MM		262.00
M-13	3X1/2X1.1/2X25MM	198.00	224.00
M-14	3X3/4X1.3/4X25MM		238.00
M-15	3X1X2X25MM		276.00
M-16	4X3/8X1.1/4X6MM	170.00	190.00
M-17	4X1/2X1.1/2X6MM	188.00	216.00
M-18	4X3/4X1.3/4X6MM	240.00	260.00
M-19	4X1X2X6MM		320.00
M-20	4X3/8X1.1/4X12MM	186.00	208.00
M-21	4X1/2X1.1/2X12MM	214.00	236.00
M-22	4X3/4X1.3/4X12MM	250.00	282.00
M-23	4X1X2X12MM		344.00
M-24	4X3/8X1.1/4X19MM	212.00	230.00
M-25	4X1/2X1.1/2X19MM	242.00	266.00
M-26	4X3/4X1.3/4X19MM	268.00	296.00
M-27	4X1X2X19MM		354.00
M-28	4X1/2X1.1/2X25MM	266.00	298.00
M-29	4X3/4X1.3/4X25MM		330.00
M-30	4X1X2X25MM		370.00

PARLIAMENT HINGES

S.S.F / ANTIQ

CODE NO.	SIZE MM/INCH	M.R.P.
G-1	3X3	568.00
G-2	3X4	730.00
G-3	4X4	826.00
G-4	4X5	954.00
G-5	4X6	1040.00
G-6	4X8	1942.00
G-7	5X4	988.00
G-8	5X5	1134.00
G-9	5X6	1296.00
G-10	5X8	2190.00
G-11	6X6	1362.00

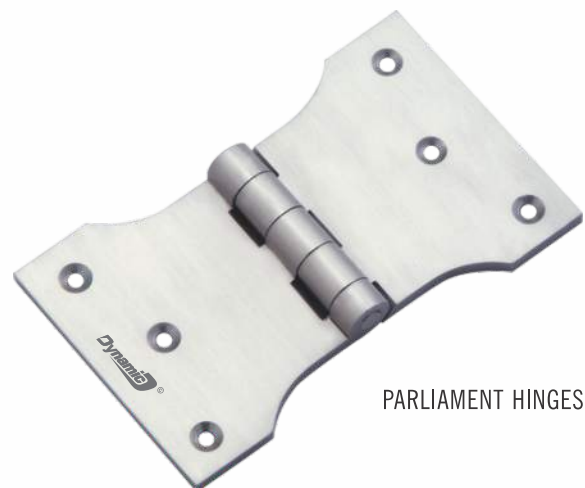

PARLIAMENT HINGES



HINGES

AN ISO 9001-2008 CERTIFIED COMPANY



Best Bounding with Brass
(M.R.P. PER PIECE)



OVERLAY HINGES - (HALF)
19X19mm.



OVERLAY HINGES - (FULL)
19X25mm.

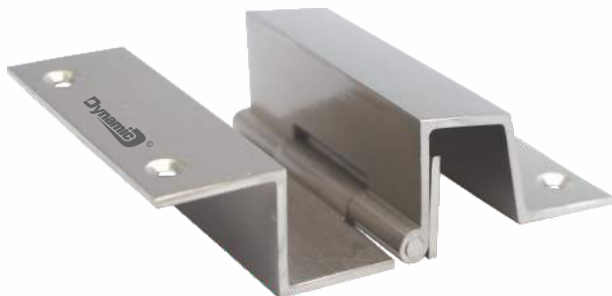

OVERLAY HINGES - (HALF)
25X25mm.

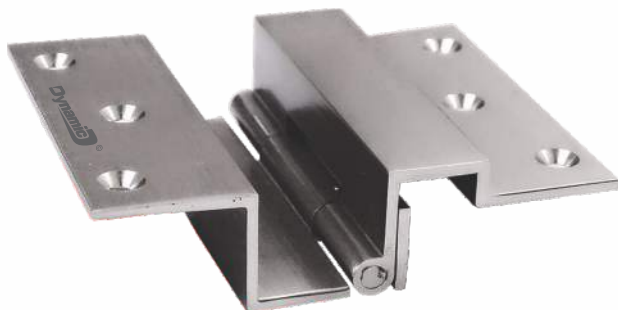

OVERLAY HINGES - (FULL)
19X19mm.

OVERLAY HINGES

S.S.FINISH

CODE NO.	SIZE MM/INCH	M.R.P. Smooth Movement
N-1	2"X19X19MM (Full)	228.00
N-2	2"X19X19MM (Half)	228.00
N-3	3"X19X19MM (Full)	332.00
N-4	3"X19X19MM (Half)	332.00
N-5	4"X19X19MM (Full)	456.00
N-6	4"X19X19MM (Half)	456.00
N-7	2"X19X25MM (Full)	234.00
N-8	2"X19X25MM (Half)	234.00
N-9	3"X19X25MM (Full)	350.00
N-10	3"X19X25MM (Half)	350.00
N-11	4"X19X25MM (Full)	466.00
N-12	4"X19X25MM (Half)	466.00
N-13	2"X25X19MM (Full)	286.00
N-14	2"X25X19MM (Half)	296.00
N-15	3"X25X19MM (Full)	426.00
N-16	3"X25X19MM (Half)	444.00
N-17	4"X25X19MM (Full)	568.00
N-18	4"X25X19MM (Half)	592.00
N-19	2"X25X25MM (Full)	284.00
N-20	2"X25X25MM (Half)	302.00
N-21	3"X25X25MM (Full)	426.00
N-22	3"X25X25MM (Half)	454.00
N-23	4"X25X25MM (Full)	572.00
N-24	4"X25X25MM (Half)	604.00



Advantages of Duck Hinges

No Need of Door Chain



No Broken Laminate Edges



Laminate Cover Full Hinges



Simultaneously Open 2 Shutters



Difference Between L Hinges & Duck Hinges Demo

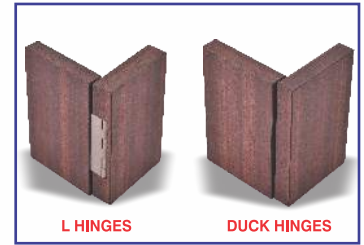

L HINGES

DUCK HINGES

INSTALLATION :

19 MM HALF OVERLAY HINGE

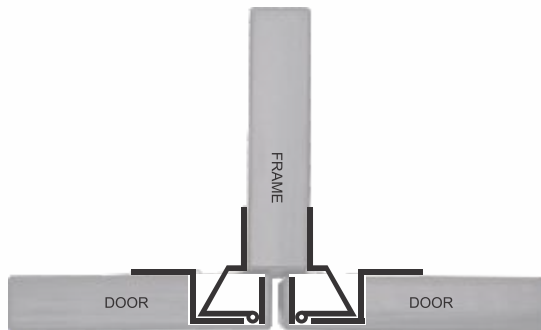

19 MM FULL OVERLAY HINGE

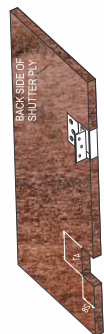

Mark & Make a slot 47x28 for 45mm Hinge, 77x28 for 75mm Hinge, 102x28 for 100 mm Hinge & Fix the Hinge in slot on Back side of Shutter Ply.

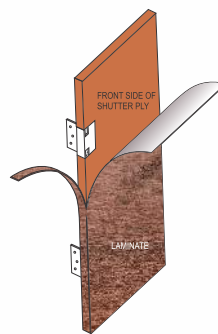

After Fixing the Hinge Paste the Laminate on Front and all Four Edges of Shutter Ply along with Prefixed Hinges.

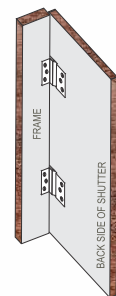

Fix other Flap of Hinge on Frame.



HINGES

AN ISO 9001-2008 CERTIFIED COMPANY



Best Bounding with Brass
(M.R.P. PER PIECE)



Z. HINGES

Z. HINGES

CODE NO.	SIZE MM/INCH	S.S.FINISH	
		M.R.P. Medium	M.R.P. Heavy
I-1	3x1/2x12mm.	124.00	144.00
I-2	4x1/2x12mm.	162.00	188.00
I-3	3x3/4x19mm.	148.00	168.00
I-4	4x3/4x19mm.	178.00	224.00



W. HINGES

W HINGES (2 IN 1 HINGES)

CODE NO.	SIZE MM/INCH	S.S.FINISH			
		M.R.P. Medium	M.R.P. Heavy	M.R.P. Medium Smooth Movement	M.R.P. Heavy Smooth Movement
J-1	1.1/2"	92.00	----	----	----
J-2	2"	118.00	142.00	132.00	154.00
J-3	3"	186.00	216.00	200.00	232.00
J-4	3x1/2x1.1/2x6MM	162.00	188.00	176.00	202.00
J-5	3x3/4x1.3/4x6MM	190.00	214.00	204.00	232.00
J-6	3x1/2x1.1/2x12MM	174.00	202.00	188.00	218.00
J-7	3x3/4x1.3/4x12MM	200.00	224.00	220.00	246.00
J-8	3x1/2x1.1/2x19MM	188.00	210.00	206.00	230.00
J-9	3x3/4x1.3/4x19MM	214.00	238.00	232.00	260.00
J-10	2" Ex.Heavy		174.00		186.00
J-11	3" Ex.Heavy		260.00		278.00



Single Action

Double Action

SPRING HINGES

CODE NO.	SIZE MM/INCH	S.S.F. / ANTIQ
		M.R.P.
F-1	4" Single Action	554.00
F-2	5" Single Action	690.00
F-3	4" Double Action	920.00
F-4	5" Double Action	1180.00



TOWER BOLT

AN ISO 9001-2008 CERTIFIED COMPANY



Best Bounding with Brass
(M.R.P. PER PIECE)



VX 3/8

FANCY KNOB 3/8

FANCY VX 3/8 TOWER BOLT (M.R.P. WITH SCREW)
S.S.F. / ANTIQ GRAPHITE PVD FINISH

CODE NO.	SIZE MM/INCH	M.R.P.	M.R.P.	M.R.P.
S-1	3X3/8	166.00	196.00	280.00
S-2	4X3/8	206.00	242.00	342.00
S-3	6X3/8	310.00	366.00	520.00
S-4	8X3/8	404.00	472.00	660.00
S-5	10X3/8	502.00	584.00	814.00
S-6	12X3/8	596.00	690.00	956.00



MARBEL
TOWER BOLT 5/16



TOWER BOLT 3/8

TOWER BOLT 3/8 S.S.F. / ANTIQ

CODE NO.	SIZE MM/INCH	M.R.P. Medium	M.R.P. Heavy
R-1	3X3/8	116.00	150.00
R-2	4X3/8	154.00	192.00
R-3	6X3/8	232.00	290.00
R-4	8X3/8	314.00	376.00
R-5	10X3/8		482.00
R-6	12X3/8		582.00
R-7	15X3/8		882.00
R-8	18X3/8		1056.00
R-9	24X3/8		1432.00

MARBEL TOWER BOLT 5/16 S.S.F. / ANTIQ

CODE NO.	SIZE MM/INCH	M.R.P.
Q-1	2.1/2X5.1/6	134.00
Q-2	3"X5.1/6	164.00
Q-3	4"X5.1/6	208.00

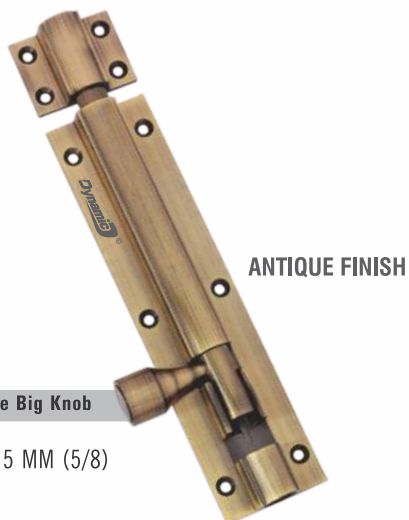

Sp. Decorative Big Knob

Tower Bolt 15 MM (5/8)

ANTIQUÉ FINISH

FANCY TOWER BOLT 15MM. (M.R.P. WITH SCREW)
S.S.F. / ANTIQ GRAPHITE PVD FINISH

CODE NO.	SIZE MM/INCH	M.R.P.	M.R.P.	M.R.P.
AH-1	6"X15MM	1126.00	1292.00	1748.00
AH-2	8"X15MM	1500.00	1712.00	2308.00
AH-3	10"X15MM	1880.00	2142.00	2882.00
AH-4	12"X15MM	2276.00	2586.00	3466.00
AH-5	15"X15MM	2940.00	3210.00	4320.00
AH-6	18"X15MM	3524.00	3852.00	5184.00
AH-7	24"X15MM	4700.00	5136.00	6912.00
AH-8	36"X15MM	7052.00	7704.00	10368.00



TOWER BOLT

AN ISO 9001-2008 CERTIFIED COMPANY



Best Bounding with Brass
(M.R.P. PER PIECE)



CLOSE HOLE 10MM

SQUARE 10MM

FANCY KNOB 10MM

TOWER BOLT 10mm.

S.S.F. / ANTIQ

(M.R.P. WITH SCREW)
GRAPHITE PVD FINISH

CODE NO.	SIZE MM/INCH	S.S.F. / ANTIQ			
		M.R.P. Medium	M.R.P. Heavy	M.R.P. Heavy	M.R.P. Heavy
V-1	4X10MM	258.00	306.00	360.00	500.00
V-2	6X10MM	378.00	430.00	506.00	714.00
V-3	8X10MM	500.00	544.00	634.00	884.00
V-4	10X10MM	624.00	696.00	808.00	1116.00
V-5	12X10MM	750.00	822.00	950.00	1306.00
V-6	15X10MM		1176.00	1362.00	1852.00
V-7	18X10MM		1436.00	1616.00	2100.00
V-8	24X10MM		1920.00	2196.00	2948.00



VX TOWER BOLT 1/2
GRAPHITE FINISH

TOWER BOLT 1/2
S.S. FINISH

FANCY KNOB 10MM
PVD GOLD

TOWER BOLT 12mm. (VX ROUND)

S.S.F. / ANTIQ

(M.R.P. WITH SCREW)
GRAPHITE PVD FINISH

CODE NO.	SIZE MM/INCH	S.S.F. / ANTIQ				
		M.R.P. Medium	M.R.P. Heavy	M.R.P. VX Ex.Heavy	M.R.P. Ex.Heavy	M.R.P. Ex.Heavy
W-1	4X1/2	222.00	294.00	350.00	412.00	578.00
W-2	6X1/2	332.00	442.00	506.00	594.00	842.00
W-3	8X1/2	442.00	588.00	670.00	780.00	1094.00
W-4	10X1/2	556.00	740.00	844.00	980.00	1366.00
W-5	12X1/2	666.00	888.00	1008.00	1168.00	1620.00
W-6	15X1/2			1346.00	1545.00	2175.00
W-7	18X1/2			1660.00	1862.00	2610.00
W-8	24X1/2			2210.00	2472.00	3480.00

MARBEL TOWER BOLT

S.S.F. / ANTIQ

(M.R.P. WITH SCREW)
GRAPHITE PVD FINISH



MARBLE

CODE NO.	SIZE MM/INCH	S.S.F. / ANTIQ				
		VX-M.R.P. Steel Rod	M.R.P. Heavy	M.R.P. VX Ex.Heavy	M.R.P. Heavy	M.R.P. Heavy
AG-1	3X3/8	134.00	160.00	188.00	220.00	310.00
AG-2	4X3/8	172.00	204.00	244.00	284.00	394.00
AG-3	6X3/8	258.00	308.00	360.00	420.00	588.00
AG-4	8X3/8	346.00	408.00	458.00	530.00	734.00
AG-5	10X3/8	434.00	508.00	592.00	684.00	940.00
AG-6	12X3/8	530.00	620.00	736.00	844.00	1148.00
AG-7	15X3/8			948.00	1065.00	1470.00
AG-8	18X3/8			1138.00	1282.00	1764.00
AG-9	24X3/8			1518.00	1694.00	2352.00



TOWER BOLT

AN ISO 9001-2008 CERTIFIED COMPANY



Best Bounding with Brass
(M.R.P. PER PIECE)



CAPSULE (HEAVY)

CAPSULE (MEDIUM)

CODE NO.	SIZE MM/INCH	(M.R.P. WITH SCREW)			
		S.S.F. / ANTIQ		GRAPHITE	PVD FINISH
		M.R.P. Medium	M.R.P. Heavy	M.R.P. Heavy	M.R.P. Heavy
Y-1	3"	158.00	----	----	----
Y-2	4"	202.00	348.00	402.00	552.00
Y-3	6"	300.00	522.00	604.00	836.00
Y-4	8"	408.00	702.00	806.00	1102.00
Y-5	10"	516.00	890.00	1020.00	1386.00
Y-6	12"	618.00	1070.00	1220.00	1654.00
Y-7	15"		1452.00	1652.00	2188.00
Y-8	18"		1740.00	1972.00	2604.00
Y-9	24"		2324.00	2620.00	3444.00



ROYAL (HEAVY)

ROYAL (MEDIUM)

CODE NO.	SIZE MM/INCH	(M.R.P. WITH SCREW)			
		S.S.F. / ANTIQ		GRAPHITE	PVD FINISH
		M.R.P. Medium	M.R.P. Heavy	M.R.P. Heavy	M.R.P. Heavy
Z-1	3"	160.00	----	----	----
Z-2	4"	210.00	342.00	396.00	544.00
Z-3	6"	312.00	512.00	592.00	822.00
Z-4	8"	418.00	658.00	756.00	1042.00
Z-5	10"	532.00	858.00	982.00	1340.00
Z-6	12"	640.00	1046.00	1196.00	1622.00
Z-7	15"		1364.00	1562.00	2088.00
Z-8	18"		1640.00	1870.00	2496.00
Z-9	24"		2240.00	2367.00	3288.00



ZYLO (HEAVY)

ZYLO (MEDIUM)

CODE NO.	SIZE MM/INCH	(M.R.P. WITH SCREW)			
		S.S.F. / ANTIQ		GRAPHITE	PVD FINISH
		M.R.P. Medium	M.R.P. Heavy	M.R.P. Heavy	M.R.P. Heavy
AA-1	3"	188.00	----	----	----
AA-2	4"	240.00	348.00	402.00	554.00
AA-3	6"	362.00	524.00	606.00	840.00
AA-4	8"	480.00	696.00	800.00	1100.00
AA-5	10"	616.00	892.00	1022.00	1392.00
AA-6	12"	736.00	1024.00	1170.00	1588.00
AA-7	15"		1432.00	1634.00	2172.00
AA-8	18"		1720.00	1954.00	2592.00
AA-9	24"		2292.00	2592.00	3428.00



TOWER BOLT

AN ISO 9001-2008 CERTIFIED COMPANY



Best Bounding with Brass
(M.R.P. PER PIECE)

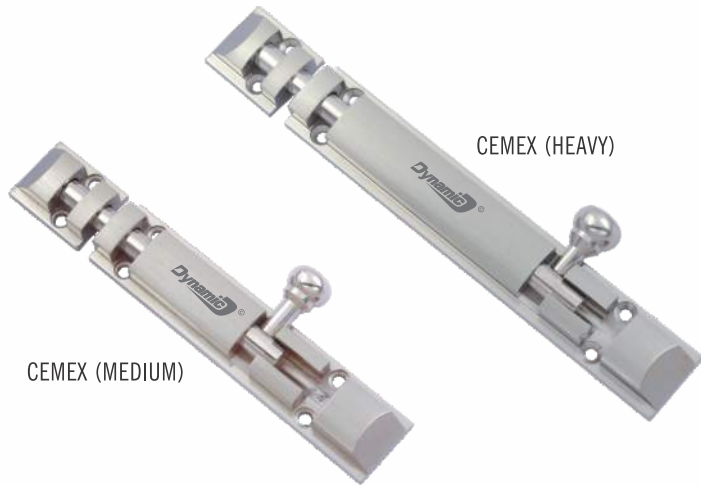

CODE NO.	SIZE MM/INCH	(M.R.P. WITH SCREW)			
		S.S.F. / ANTIQ M.R.P. Medium	S.S.F. / ANTIQ M.R.P. Heavy	GRAPHITE M.R.P. Heavy	PVD FINISH M.R.P. Heavy
AB-1	3"	176.00	---	---	---
AB-2	4"	232.00	346.00	400.00	548.00
AB-3	6"	342.00	516.00	596.00	828.00
AB-4	8"	460.00	684.00	786.00	1082.00
AB-5	10"	586.00	880.00	1008.00	1372.00
AB-6	12"	706.00	1050.00	1200.00	1628.00
AB-7	15"		1416.00	1614.00	2144.00
AB-8	18"		1740.00	1970.00	2598.00
AB-9	24"		2322.00		

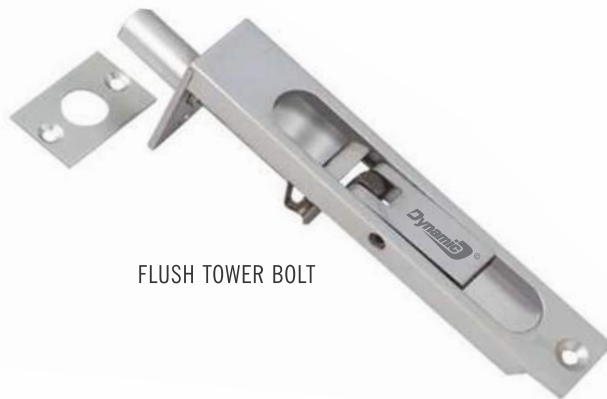

CODE NO.	SIZE MM/INCH	S.S.F. / ANTIQ	
		M.R.P. 3/4"	M.R.P. 1"
AQ-1	4"	152.00	---
AQ-2	6"	228.00	270.00
AQ-3	8"	304.00	360.00
AQ-4	10"	380.00	450.00
AQ-5	12"	456.00	540.00
AQ-6	18"	792.00	900.00
AQ-7	24"	1056.00	1200.00

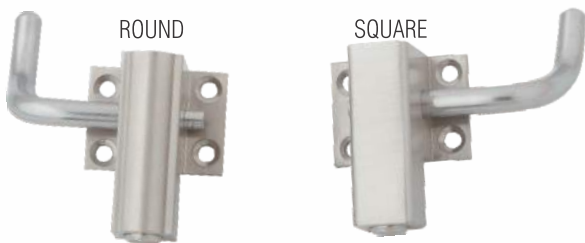

CAM BOLT (MRP PER PAIR)		S.S.FINISH
CODE NO.	SIZE MM/INCH	M.R.P.
AK-1	Round (Medium)	238.00
AK-2	Round (Havey)	268.00
AK-3	Square (Havey)	298.00
AK-4	Round (Aluminium)	166.00

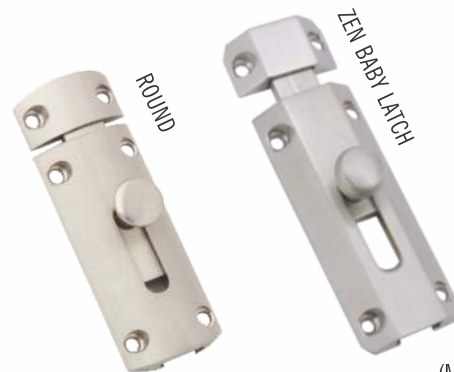

CODE NO.	SIZE MM/INCH	(M.R.P. WITH SCREW)		
		S.S.F. / ANTIQ M.R.P.	GRAPHITE M.R.P.	PVD FINISH M.R.P.
AL-1	3" Round	180.00	212.00	294.00
AL-2	4" Round	236.00	274.00	376.00
AL-3	Zen Baby Latch 3"	180.00	212.00	294.00
AL-4	Zen Baby Latch 4"	236.00	274.00	376.00



ALDROPS

AN ISO 9001-2008 CERTIFIED COMPANY



Best Bounding with Brass
(M.R.P. PER PIECE)



V. PLAIN

ALDROPS V-PLAIN

S.S.F. / ANTIQ

CODE NO.	SIZE MM/INCH	M.R.P.
AW-1	8"X5/8 (2X1)	1680.00
AW-2	10"X5/8 (2X1)	1808.00
AW-3	12"X5/8 (3X1)	2220.00
AW-4	14"X5/8 (3X1)	2350.00
AW-5	16"X5/8 (3X1)	2530.00
AW-6	12"X3/4 (3X1)	3524.00
AW-7	14"X3/4 (3X1)	3752.00
AW-8	16"X3/4 (3X1)	4048.00
AW-9	18"X3/4 (3X1)	4278.00
AW-10	20"X3/4 (3X1)	4508.00
AW-11	22"X3/4 (3X1)	4738.00
AW-12	24"X3/4 (3X1)	4968.00

ALDROPS JORJAN

S.S.F. / ANTIQ

CODE NO.	SIZE MM/INCH	M.R.P.
AW-1	8"X5/8 (2X1)	1624.00
AW-2	10"X5/8 (2X1)	1760.00
AW-3	12"X5/8 (3X1)	2132.00
AW-4	14"X5/8 (3X1)	2310.00
AW-5	16"X5/8 (3X1)	2452.00
AW-6	12"X3/4 (3X1)	3620.00
AW-7	14"X3/4 (3X1)	3844.00
AW-8	16"X3/4 (3X1)	4076.00
AW-9	18"X3/4 (3X1)	4382.00
AW-10	20"X3/4 (3X1)	4620.00
AW-11	22"X3/4 (3X1)	4856.00
AW-12	24"X3/4 (3X1)	5092.00



JORJAN ALDROPS



PLUS POINT TADI

TADI PLUS POINT

S.S.F. / ANTIQ

CODE NO.	SIZE MM/INCH	M.R.P.
AV-1	8"X1/2	930.00
AV-2	10"X1/2	1020.00
AV-3	12"X1/2	1110.00



PLUS POINT

ALDROPS PLUS POINT

S.S.F. / ANTIQ

CODE NO.	SIZE MM/INCH	M.R.P.
AU-1	8"X5/8 (2X1)	1252.00
AU-2	10"X5/8 (2X1)	1390.00
AU-3	12"X5/8 (3X1)	1668.00
AU-4	14"X5/8 (3X1)	1840.00
AU-5	16"X5/8 (3X1)	1984.00
AU-6	18"X5/8 (3X1)	2124.00



GATE HOOKS

AN ISO 9001-2008 CERTIFIED COMPANY



Best Bounding with Brass
(M.R.P. PER PIECE)



GATE HOOK (MEDIUM)



GATE HOOK (HEAVY)



FANCY SMALL RING



FANCY BIG RING

GATE HOOK (MEDIUM)

S.S.F. / ANTIQ

CODE NO.	SIZE MM/INCH	M.R.P.
AM-1	2"	68.00
AM-2	2,1/2"	70.00
AM-3	3"	74.00
AM-4	4"	80.00
AM-5	5"	85.00
AM-6	6"	90.00

GATE HOOK (HEAVY)

S.S.F. / ANTIQ

CODE NO.	SIZE MM/INCH	M.R.P.
AN-1	2"	81.00
AN-2	2,1/2"	85.00
AN-3	3"	88.00
AN-4	4"	90.00
AN-5	5"	98.00
AN-6	6"	100.00

FANCY SMALL RING GATE HOOK

S.S.F. / ANTIQ

GRAPHITE

PVD FINISH

CODE NO.	SIZE MM/INCH	M.R.P.	M.R.P.	M.R.P.
AO-1	2,1/2"	82.00	102.00	150.00
AO-2	3"	86.00	106.00	156.00
AO-3	4"	92.00	112.00	164.00
AO-4	5"	96.00	118.00	172.00
AO-5	6"	100.00	122.00	178.00

FANCY BIG RING GATE HOOK

S.S.F. / ANTIQ

GRAPHITE

PVD FINISH

CODE NO.	SIZE MM/INCH	M.R.P.	M.R.P.	M.R.P.
AP-1	4"	94.00	116.00	168.00
AP-2	5"	112.00	134.00	194.00
AP-3	6"	116.00	140.00	200.00
AP-4	8"	140.00	166.00	232.00



DOOR/WINDOW FITTINGS

AN ISO 9001-2008 CERTIFIED COMPANY



Best Bounding with Brass
(M.R.P. PER PIECE)



WINDOW ADJUSTER

WINDOW ADJUSTER

S.S.F. / ANTIQ

CODE NO.	SIZE MM/INCH	M.R.P.
AR-1	8"	154.00
AR-2	10"	168.00
AR-3	12"	184.00



FLAT 6"
(HEAVY / MEDIUM)



DELUXE WINDOW STAY 6"
(HEAVY / MEDIUM)

WINDOW STAY (DELUXE)

S.S.F. / ANTIQ

CODE NO.	SIZE MM/INCH	M.R.P.
AS-1	Flat 6" (Medium)	324.00
AS-2	Flat 6" (Havey)	366.00
AS-3	Deluxe 6" (Medium)	192.00
AS-4	Deluxe 6" (Havey)	226.00
AS-5	Sliding M.	344.00
AS-6	Sliding H.	420.00



SLIDING WINDOW



HEAVY SLIDING WINDOW

PANEL LOCK - MEDIUM

RATE WITHOUT KEY

CODE NO.	SIZE MM/INCH	M.R.P. S.S.F.
DW-1	19mm Medium	66.00
DW-2	25mm Medium	70.00
DW-3	31mm Medium	76.00
DW-4	35mm Big Medium	78.00
DW-5	50mm Big Medium	88.00
DW-6	MS Key	15.00
DW-7	Steel Key	28.00



MS KEY

50MM BIG
MEDIUM



BRASS KEY



25MM
MEDIUM



50MM BIG
HEAVY



31MM
HEAVY



BRASS KEY

PANEL LOCK - HEAVY

RATE WITHOUT KEY

CODE NO.	SIZE MM/INCH	M.R.P. S.S.F.
AX-1	25mm Heavy	92.00
AX-2	31mm Heavy	96.00
AX-3	35mm Big Heavy	202.00
AX-4	50mm Big Heavy	224.00
AX-5	Steel Key SSF	24.00



FITTINGS

AN ISO 9001-2008 CERTIFIED COMPANY



Best Bounding with Brass
(M.R.P. PER PIECE)

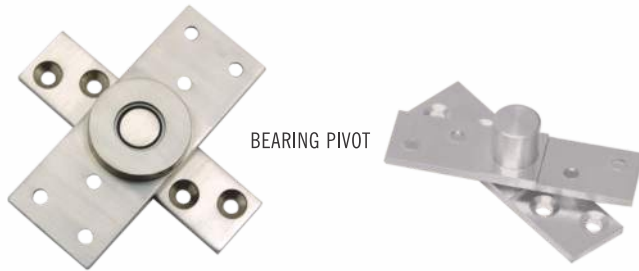

BEARING PIVOT

BEARING PIVOT

CODE NO.	SIZE MM/INCH	M.R.P.
AY-1	3X3/4	112.00
AY-2	4X1	208.00
AY-3	5X1	380.00
AY-4	6X1	444.00
AY-5	4X1X1.1/4	----
AY-6	4X1.1/4X1.1/4	564.00
AY-7	5X1.1/4X1.1/4	894.00
AY-8	6X1.1/4X1.1/4	1002.00
AY-9	8X2.5	3440.00



ROAD LATCH

CODE NO.	SIZE MM/INCH	M.R.P. Medium	M.R.P. Heavy
BA-1	Steel Rod 6"	98.00	172.00
BA-2	Steel Rod 8"	112.00	194.00
BA-3	Steel Rod 10"	124.00	214.00
BA-4	Steel Rod 12"	140.00	242.00



L PATTI

CODE NO.	SIZE MM/INCH	M.R.P.
BB-1	5.1/6"	10=00
BB-2	3/8"	12=00
BB-3	1/2"	14=00



'D' BRACKET

CODE NO.	SIZE MM/INCH	M.R.P. Medium	M.R.P. Heavy
BD-1	2X6MM	34.00	54.00
BD-2	2X8MM	38.00	56.00
BD-3	2X10MM	41.00	58.00
BD-4	2X12MM	42.00	60.00
BD-5	2X12MM Ex. H		84.00



SQUARE FOLDING

CODE NO.	SIZE MM/INCH	M.R.P. Medium	M.R.P. Heavy
BF-1	1X6MM	----	46.00
BF-2	1X8MM	39.00	50.00
BF-3	1X12MM	43.00	54.00
BF-4	2X6MM	----	92.00
BF-5	2X8MM	73.00	94.00
BF-6	2X12MM	80.00	110.00
BF-7	3X1.1/2X12MM	220.00	388.00



BRACKET

AN ISO 9001-2008 CERTIFIED COMPANY



Best Bounding with Brass
(M.R.P. PER PIECE)



SQUARE FOLDING



SQUARE FOLDING

SQUARE BRACKET

CODE NO.	SIZE MM/INCH	M.R.P. Medium	M.R.P. Heavy
BE-1	1X6MM	27.00	39.00
BE-2	1X8MM	29.00	44.00
BE-3	1X12MM	31.00	47.00
BE-4	2X6MM	53.00	78.00
BE-5	2X8MM	56.00	88.00
BE-6	2X12MM	64.00	94.00



PIVOT

PIVOT

CODE NO.	SIZE MM/INCH	M.R.P. Medium	M.R.P. Heavy
BG-1	2 x 6MM	53.00	78.00
BG-2	2 x 8MM	58.00	81.00
BG-3	2" x 1.1/4 x 6MM		146.00
BG-4	2.1/2x 1.1/2x8MM		210.00
BG-5	2.1/2x1.1/2x12MM		254.00



FANCY MIRROR BRACKET

FANCY MIRROR BRACKET

CODE NO.	SIZE MM/INCH	M.R.P.
BI-1	1X6MM Half	54.00
BI-2	1X8MM Half	62.00
BI-3	1X6MM Full	64.00
BI-4	1X8MM Full	78.00



BRACKET/DOOR EYE

AN ISO 9001-2008 CERTIFIED COMPANY



Best Bounding with Brass
(M.R.P. PER PIECE)



BAT HEAVY



L-BUTTON HEAVY



BAT HEAVY - MEDIUM



SINGLE-DOUBLE
MEDIUM BAT

GLASS BAT

CODE NO.	SIZE MM/INCH	M.R.P. SSF	M.R.P. CP
BJ-1	Medium	17.00	17.00
BJ-2	Heavy	23.00	24.00
BJ-3	Single L. Bat (Prem.)	26.00	27.00
BJ-4	Double L. Bat (Prem.)	38.00	40.00
BJ-5	Single L. Bat (Med.)		14.00
BJ-6	Double L. Bat (Med.)		22.00



ROUND



FANCY ROUND



FANCY SQUARE

KEY HOLE (M.R.P. PER PIECE)

CODE NO.	SIZE MM/INCH	M.R.P.
BP-1	Round (Medium)	17.00
BP-2	Round (Heavy)	19.00
BP-3	Fancy Round (Medium)	20.00
BP-4	Fancy Round (Heavy)	22.00
BP-5	Fancy Square (Medium)	22.00
BP-6	Fancy Square (Heavy)	24.00



OVAL SOCKET MEDIUM



OVAL SOCKET HEAVY

OVAL SOCKET (M.R.P. PER PAIR)

CODE NO.	SIZE MM/INCH	M.R.P.
BM-1	Ovel 3/4" (Medium)	Pair. 88.00
BM-2	Ovel 3/4" (EX.H)	Pair. 184.00



BIG ROUND

DOOR EYE

CODE NO.	SIZE MM/INCH	M.R.P.
BQ-1	Round 1.3/4"	134.00
BQ-2	Round 3"	174.00



GLASS HINGES

AN ISO 9001-2008 CERTIFIED COMPANY



Best Bounding with Brass
(M.R.P. PER PIECE)



HOLE TO GLASS
CODE NO. DX = 2
M.R.P. 156.00



P.G. HINGES
CODE NO. DX = 3
M.R.P. 100.00



GLASS KNOB
CODE NO. DX = 7
SIZE : 1" M.R.P. 78.00
SIZE : 2" M.R.P. 152.00



PLY TO GLASS
CODE NO. DX = 5
M.R.P. 432.00



CORNER GLASS HINGES
CODE NO. DX = 9
M.R.P. 432.00



ROUND

PUSH MAGNET

CODE NO.	SIZE MM/INCH	M.R.P.
BR-1	Round (Medium)	102.00
BR-2	Round (Heavy)	134.00



BRASS CORNER SELF

AN ISO 9001-2008 CERTIFIED COMPANY



Best Bounding with Brass
(M.R.P. PER PIECE)



CODE NO. DR = 1

Size	M.R.P.
6x12	1588.00
6x15	1644.00
6x18	1700.00



CODE NO. DR = 3

Size	M.R.P.
6x12	1219.00
6x15	1288.00
6x18	1358.00



CODE NO. DR = 2

Size	M.R.P.
6x12	1588.00
6x15	1644.00
6x18	1700.00



CODE NO. DR = 4

Size	M.R.P.
6x12	1588.00
6x15	1644.00
6x18	1702.00

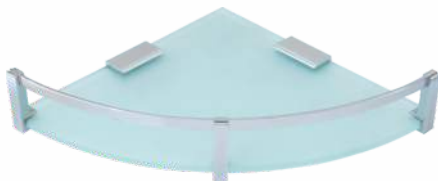

CODE NO. DR = 5

Size	6mm M.R.P.	8mm M.R.P.
8x8	966.00	1036.00
10x10	1036.00	1104.00
12x12	1080.00	1586.00



CODE NO. DR = 6

Size	M.R.P.
8x8	1242.00
10x10	1334.00
12x12	1470.00



CODE NO. DR = 7

Size	M.R.P.
8x8	1242.00
10x10	1340.00
12x12	1470.00



BRASS KHUTI

AN ISO 9001-2008 CERTIFIED COMPANY



Best Bounding with Brass
(M.R.P. PER HOOK)



PLATE CODE NO. DH
M.R.P. : 98.00



KITKAT CODE NO. DO
M.R.P. : 104.00



KAJU CODE NO. DI
M.R.P. : 98.00



PYAJO CODE NO. DN
M.R.P. : 98.00



APPLE CODE NO. DS
M.R.P. : 104.00

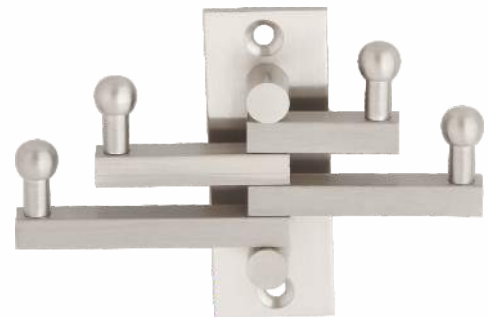

CODE NO. DQ
M.R.P. : 244.00
(SSF/ANTIQ)



MALA GOTI 12"

MALA VARAM 12"

MADHURI 12"

DY-1 | MalaGoti 12"
(28 Rod+8 S.Hook Set)
M.R.P. 16,020/- per set

DY-2 | Mala Varam 12"
(28 Rod+8 S.Hook Set)
M.R.P. 15,260/- per set

DY-3 | Madhuri 12"
(28 Rod+8 S.Hook Set)
M.R.P. 18,040/- per set



SINGLE

DOUBLE

HOOK

DY-4 | Single Peacock Set
(Single 28pc. + Double 28pc. +8 S.Hook Set)
M.R.P. 29,268/- per set



DY-5 | Georgian 4"
(84 Rod+8 S.Hook Set)
M.R.P. 22,230/- per set



DY-6 | Goli 4"
(84 Rod+8 S.Hook Set)
M.R.P. 21,620/- per set



DOLL
CODE NO.
DY 07



ELEPHANT
CODE NO.
DY 07



HORSE
CODE NO.
DY 07



PARROT
CODE NO.
DY 07



PEACOCK
CODE NO.
DY 07



LION
CODE NO.
DY 07

DY-7 | Zoola Animals 4"
(16pc Animal+68pc Georgian
+ 8pc S.Hook Set)
M.R.P. 28,340/- per set



DY-08
Bearing Kada (Patti)
M.R.P. 2840/- per pair



DY-09
Bearing Kada (Plate)
M.R.P. 5540/- per pair



DY-10
4" Regular Bottom Kada (4pc. Set)
M.R.P. 2480/- per Set



DY-11
4" Fancy Bottom Kada(4pc. Set)
M.R.P. 2772/- per Set



DY-12
6" Long Thread Bottom Kada(4pc. Set)
M.R.P. 3000/- per Set



DY-13
'9' Hook
M.R.P. 376/- per pc.



DY-14
'W' Hook
M.R.P. 412/- per pc.



DY-15
'S' Hook
M.R.P. 226/- per pc.



FANCY CAP / FANCY BRACKET

AN ISO 9001-2008 CERTIFIED COMPANY



Best Bounding with Brass
(M.R.P. PER PIECE)



STAR FULL

MIRROR BRACKET FULL

CODE NO.	SIZE MM/INCH	M.R.P. PREMIUM	M.R.P. DELUXE
CD-1	1X6mm	78.00	58.00
CD-2	1X8mm	86.00	
CD-3	1x12mm	104.00	



STAR HALF

25mm STAR HALF (DABBI)

CODE NO.	SIZE MM/INCH	M.R.P. PREMIUM	M.R.P. DELUXE
CC-1	1X6mm	64.00	50.00
CC-2	1X8mm	74.00	
CC-3	1X12mm	92.00	



CRYSTAL MIRROR BRACKET FULL

BRASS MIRROR BRACKET FULL

CODE NO.	SIZE MM/INCH	M.R.P. PREMIUM	M.R.P. DELUXE
BZ-1	1X6mm	82.00	45.00
BZ-2	1X8mm	92.00	
BZ-3	1X12mm	132.00	



CRYSTAL MIRROR BRACKET HALF

BRASS CRYSTAL HALF(DABBI)

CODE NO.	SIZE MM/INCH	M.R.P. PREMIUM	M.R.P. DELUXE
BW-1	1X6mm	72.00	38.00
BW-2	1X8mm	82.00	
BW-3	1X12mm	94.00	



ROUND MIRROR CAP

ROUND MIRROR CAP

CODE NO.	SIZE MM/INCH	M.R.P. CP
BS-1	1/2"	16.00
BS-2	3/4"	21.00
BS-3	1"	30.00
BS-4	1.1/4"	50.00
BS-5	1.1/2"	64.00
BS-6	2"	87.00
BS-7	2.1/2"	264.00
BS-8	3"	420.00



CRYSTAL MIRROR CAP

BRASS CRYSTAL CAP

CODE NO.	SIZE MM/INCH	M.R.P. PREMIUM	M.R.P. CP
BY-1	1/2"	30.00	15.00
BY-2	3/4"	41.00	22.00
BY-3	1"	52.00	24.00
BY-4	1.1/4"	138.00	
BY-5	1.1/2"	198.00	



ROYAL PYRAMID

BRASS ROYAL PYRAMID

CODE NO.	SIZE MM/INCH	M.R.P. SSF/ANT.
BV-1	1.1/2"	90.00
BV-2	2"	144.00
BV-3	2.1/2"	244.00
BV-4	3"	388.00



FLOWER DOOM

BRASS FLOWER DOOM'S

CODE NO.	SIZE MM/INCH	M.R.P. SSF/ANT.
CH-1	1"	32.00
CH-2	1.1/4"	36.00
CH-3	1.1/2"	64.00
CH-4	2"	90.00
CH-5	2.1/2"	166.00
CH-6	3"	206.00

BRASS ROYAL RAJWADI DOME



ROYAL RAJWADI DOME

CODE NO.	SIZE MM/INCH	M.R.P. SSF/ANT.
DE-1	1.1/2"	80.00
DE-2	2"	112.00
DE-3	2.1/2"	202.00
DE-4	3"	402.00

Dynamic[®]

Best Bounding with Brass

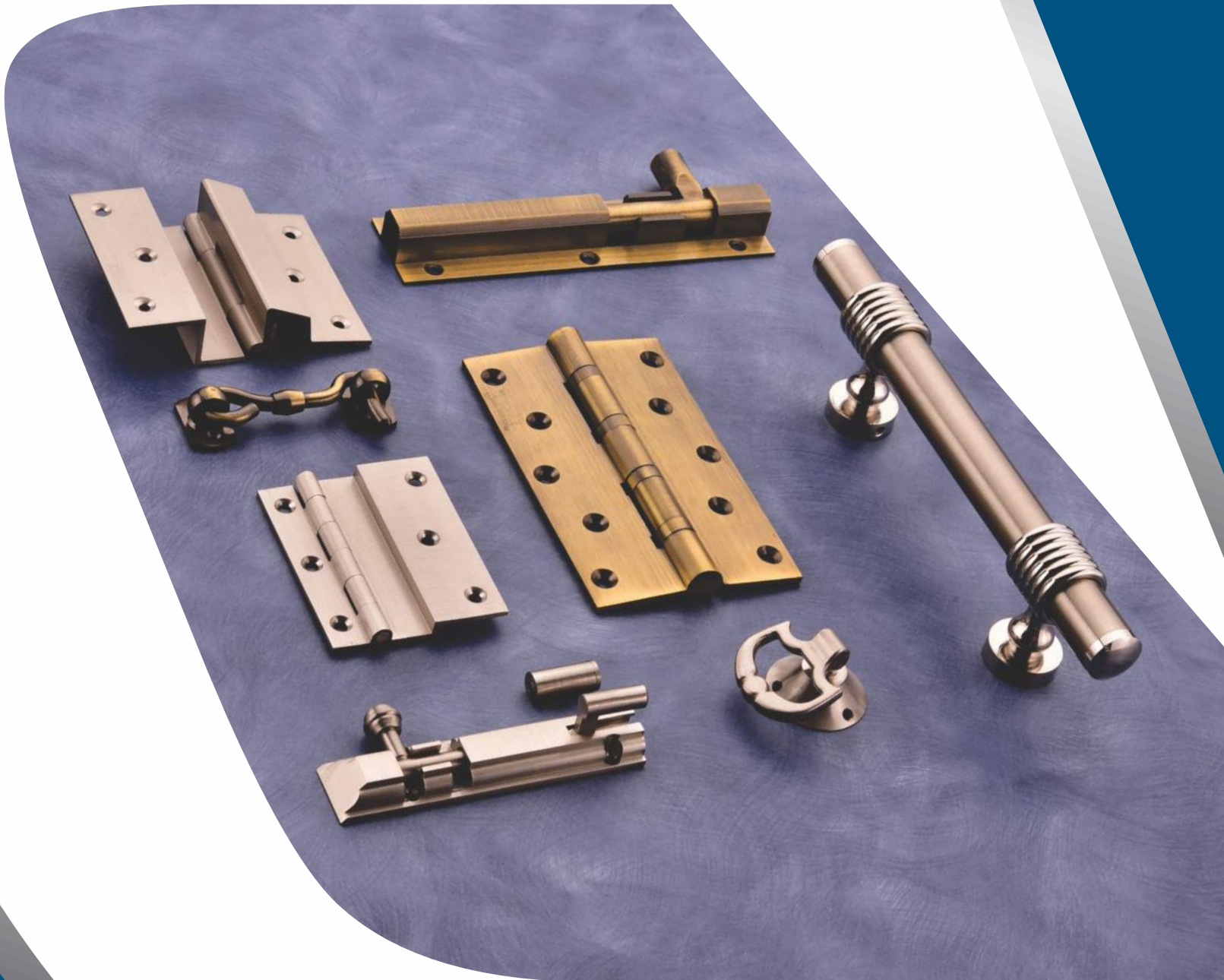

Manufacturer

STS BRASS INDUSTRIES

Plot No. 464/167, GIDC-1, Shanker Tekri, Jamnagar-361004. (Gujarat) INDIA.

Mo. +91 92277 03852

Visit us at: ***www.dynamicbrass.in***